



# 目 录

一、运输作业组织与管理模块..... 2

二、仓储与配送作业组织与管理模块..... 34

三、国际物流作业组织与管理模块..... 150

|                       |     |
|-----------------------|-----|
| 四、 快递物流作业组织与管理模块..... | 213 |
|-----------------------|-----|

湖南商务职业技术学院物流管理专业学生技能考核题库

## 一、运输作业组织与管理模块

○

○

○

|  |  |  |
|--|--|--|
|  |  |  |
|--|--|--|

○

○

|  |  |  |
|--|--|--|
|  |  |  |
|  |  |  |
|  |  |  |
|  |  |  |
|  |  |  |

|  |  |  |  |  |
|--|--|--|--|--|
|  |  |  |  |  |
|--|--|--|--|--|

|  |  |  |  |  |  |
|--|--|--|--|--|--|
|  |  |  |  |  |  |
|  |  |  |  |  |  |
|  |  |  |  |  |  |
|  |  |  |  |  |  |
|  |  |  |  |  |  |
|  |  |  |  |  |  |
|  |  |  |  |  |  |
|  |  |  |  |  |  |

## ( ) 任务描述

- :
- 
-





|   |  |  |  |   |  |   |  |  |
|---|--|--|--|---|--|---|--|--|
|   |  |  |  |   |  |   |  |  |
|   |  |  |  |   |  |   |  |  |
|   |  |  |  |   |  |   |  |  |
|   |  |  |  |   |  |   |  |  |
|   |  |  |  |   |  |   |  |  |
| <input type="checkbox"/> <input type="checkbox"/> |  |  |  | <input type="checkbox"/> <input type="checkbox"/> |  |   |  |  |
| <input type="checkbox"/> <input type="checkbox"/> |  |  |  |   |  |   |  |  |
|   |  |  |  |   |  |   |  |  |
|   |  |  |  |   |  | <input type="checkbox"/> <input type="checkbox"/> <input type="checkbox"/> <input type="checkbox"/> |  |  |
|   |  |  |  |   |  |   |  |  |
|   |  |  |  |   |  |   |  |  |



|  |  |  |
|--|--|--|
|  |  |  |
|  |  |  |
|  |  |  |
|  |  |  |
|  |  |  |

|  |  |  |  |  |  |
|--|--|--|--|--|--|
|  |  |  |  |  |  |
|  |  |  |  |  |  |
|  |  |  |  |  |  |
|  |  |  |  |  |  |
|  |  |  |  |  |  |
|  |  |  |  |  |  |
|  |  |  |  |  |  |
|  |  |  |  |  |  |
|  |  |  |  |  |  |

( ) 任务描述:

- 
- 
- 

|  |  |  |  |  |  |  |
|--|--|--|--|--|--|--|
|  |  |  |  |  |  |  |
|  |  |  |  |  |  |  |
|  |  |  |  |  |  |  |
|  |  |  |  |  |  |  |
|  |  |  |  |  |  |  |
|  |  |  |  |  |  |  |
|  |  |  |  |  |  |  |
|  |  |  |  |  |  |  |
|  |  |  |  |  |  |  |
|  |  |  |  |  |  |  |
|  |  |  |  |  |  |  |



|  |  |  |
|--|--|--|
|  |  |  |
|  |  |  |
|  |  |  |
|  |  |  |
|  |  |  |

|  |  |  |  |  |
|--|--|--|--|--|
|  |  |  |  |  |
|  |  |  |  |  |
|  |  |  |  |  |
|  |  |  |  |  |

|  |  |  |  |  |  |
|--|--|--|--|--|--|
|  |  |  |  |  |  |
|  |  |  |  |  |  |
|  |  |  |  |  |  |
|  |  |  |  |  |  |
|  |  |  |  |  |  |
|  |  |  |  |  |  |



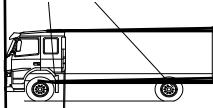
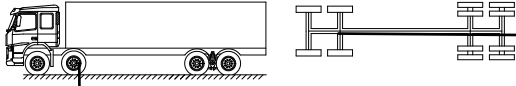
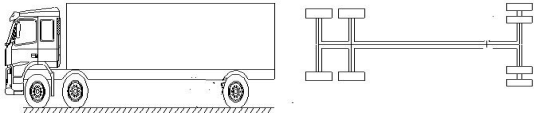

|  |  |  |  |  |  |
|--|--|--|--|--|--|
|  |  |  |  |  |  |
|  |  |  |  |  |  |
|  |  |  |  |  |  |
|  |  |  |  |  |  |
|  |  |  |  |  |  |
|  |  |  |  |  |  |
|  |  |  |  |  |  |
|  |  |  |  |  |  |

( ) 任务描述:



|  |  |  |
|--|--|--|
|  |  |  |
|  |  |  |
|  |  |  |
|  |  |  |

|  |  |  |
|--|--|--|
|  |  |  |
|  |  |  |
|  |  |  |
|  |  |  |

|  |  |  |
|--|--|--|
|  |  |  |
|  |  |  |
|  |  |  |
|  |  |  |



○

○

○

○

○

|  |  |  |
|--|--|--|
|  |  |  |
|  |  |  |
|  |  |  |
|  |  |  |
|  |  |  |

|  |  |  |  |  |
|--|--|--|--|--|
|  |  |  |  |  |
|  |  |  |  |  |

|  |  |  |  |  |  |
|--|--|--|--|--|--|
|  |  |  |  |  |  |
|  |  |  |  |  |  |
|  |  |  |  |  |  |
|  |  |  |  |  |  |
|  |  |  |  |  |  |
|  |  |  |  |  |  |
|  |  |  |  |  |  |

( ) 任务描述



**D**

|   |  |  |   |  |  |   |  |  |  |
|---|--|--|---|--|--|---|--|--|--|
|   |  |  |   |  |  |   |  |  |  |
|   |  |  |   |  |  |   |  |  |  |
|   |  |  |   |  |  |   |  |  |  |
|   |  |  |   |  |  |   |  |  |  |
|   |  |  |   |  |  |   |  |  |  |
| <input type="checkbox"/> <input type="checkbox"/> |  |  | <input type="checkbox"/> <input type="checkbox"/> |  |  |   |  |  |  |
| <input type="checkbox"/> <input type="checkbox"/> |  |  |   |  |  |   |  |  |  |
|   |  |  |   |  |  | <input type="checkbox"/> <input type="checkbox"/> <input type="checkbox"/> <input type="checkbox"/> |  |  |  |
|   |  |  |   |  |  |   |  |  |  |
|   |  |  |   |  |  |   |  |  |  |



|   |  |  |  |
|---|--|--|--|
|   |  |  |  |
|  |  |  |  |
|  |  |  |  |
|  |  |  |  |



**2**

|  |  |  |
|--|--|--|
|  |  |  |
|  |  |  |
|  |  |  |
|  |  |  |
|  |  |  |

**3**

**4**

|  |  |  |  |
|--|--|--|--|
|  |  |  |  |
|  |  |  |  |

|  |  |  |  |  |  |
|--|--|--|--|--|--|
|  |  |  |  |  |  |
|  |  |  |  |  |  |
|  |  |  |  |  |  |
|  |  |  |  |  |  |
|  |  |  |  |  |  |
|  |  |  |  |  |  |
|  |  |  |  |  |  |

( ) 任务描述

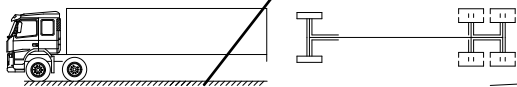
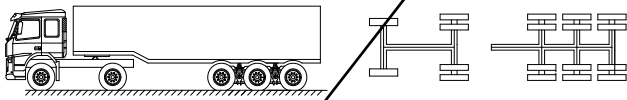
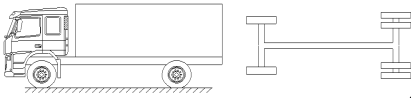
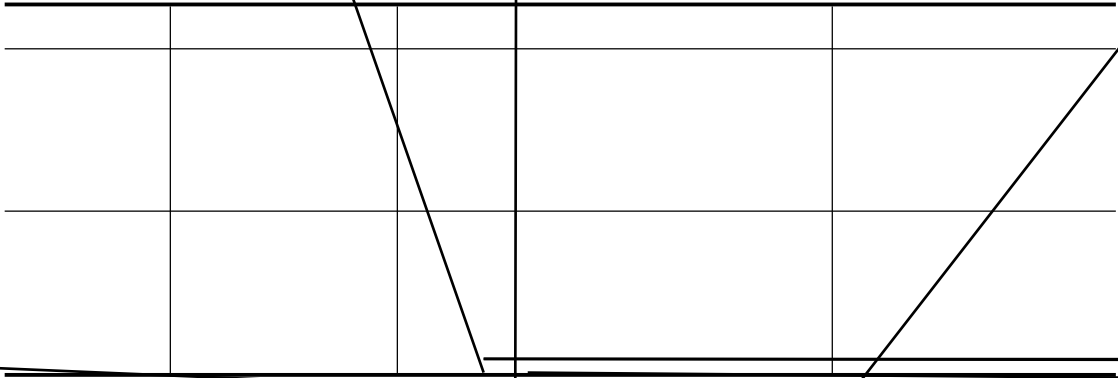



|  |  |  |
|--|--|--|
|  |  |  |
|  |  |  |
|  |  |  |
|  |  |  |
|  |  |  |

|  |  |  |  |  |
|--|--|--|--|--|
|  |  |  |  |  |
|  |  |  |  |  |
|  |  |  |  |  |
|  |  |  |  |  |



|  |  |  |  |  |
|--|--|--|--|--|
|  |  |  |  |  |
|  |  |  |  |  |
|  |  |  |  |  |
|  |  |  |  |  |
|  |  |  |  |  |
|  |  |  |  |  |

( ) 任务描述

- 
- 
- 
- 
- 

|  |  |  |
|--|--|--|
|  |  |  |
|  |  |  |
|  |  |  |

|  |  |  |
|--|--|--|
|  |  |  |
|  |  |  |
|  |  |  |

|  |  |  |  |  |
|--|--|--|--|--|
|  |  |  |  |  |
|  |  |  |  |  |
|  |  |  |  |  |
|  |  |  |  |  |
|  |  |  |  |  |
|  |  |  |  |  |

|  |  |  |  |  |  |
|--|--|--|--|--|--|
|  |  |  |  |  |  |
|  |  |  |  |  |  |
|  |  |  |  |  |  |

( ) 任务描述

( )

( )

|  |  |   |     |  |  |
|--|--|---|-----|--|--|
|  |  |   |     |  |  |
|  |  | ) | ( ) |  |  |
|  |  |   |     |  |  |

( )

( )

( )

( )

( )

|  |  |  |
|--|--|--|
|  |  |  |
|  |  |  |
|  |  |  |
|  |  |  |
|  |  |  |
|  |  |  |
|  |  |  |
|  |  |  |
|  |  |  |

○

|     |  |  |  |
|-----|--|--|--|
| ( ) |  |  |  |
|     |  |  |  |
|     |  |  |  |
|     |  |  |  |
|     |  |  |  |
|     |  |  |  |
|     |  |  |  |
|     |  |  |  |
|     |  |  |  |
|     |  |  |  |
|     |  |  |  |
|     |  |  |  |



Sailing Schedule from : Shenzhen,Shenzhen,Guangdong,China

To : Los Angeles,Los Angeles,CA,United States

Origin City : Shenzhen,Shenzhen,Guangdong,China

CY/DOOR

Destination City : Los Angeles,Los Angeles,CA,United States

CY/DOOR

| 序列号 | 航线   | 船名                | 航次     | 截关时间             | 装货港     | 预计离港时间     | 实际离港时间 | 卸货港         |
|-----|------|-------------------|--------|------------------|---------|------------|--------|-------------|
| 1   | YPSW | YM UNISON         | 59E    | 2016-04-22 17:00 | Yantian | 2016-04-25 |        | Los Angeles |
| 2   | SEA  | NORTHERN JAVELIN  | 002E   | 2016-04-23 12:00 | Yantian | 2016-04-27 |        | Long Beach  |
| 3   | AAS2 | CMA CGM LIBRA     | 095TXE | 2016-04-25 16:00 | Yantian | 2016-04-28 |        | Long Beach  |
| 4   | YPSW | YM UBIQUITY       | 22E    | 2016-04-29 17:00 | Yantian | 2016-05-02 |        | Los Angeles |
| 5   | SEA  | C SCL PUSAN       | 117E   | 2016-04-30 12:00 | Yantian | 2016-05-04 |        | Long Beach  |
| 6   | AAS2 | CMA CGM COLUMBA   | 097TXE | 2016-05-02 16:00 | Yantian | 2016-05-05 |        | Long Beach  |
| 7   | SEA  | COSCO NINGBO      | 069W   | 2016-05-06 11:00 | Yantian | 2016-05-08 |        | Long Beach  |
| 8   | YPSW | YM JIREBY         | 50E    | 2016-05-06 17:00 | Yantian | 2016-05-09 |        | Los Angeles |
| 9   | SEA  | COSCO EXCELLENCE  | 027E   | 2016-05-07 12:00 | Yantian | 2016-05-11 |        | Long Beach  |
| 10  | AAS2 | CMA CGM CENTAURUS | 099TXE | 2016-05-09 16:00 | Yantian | 2016-05-12 |        | Long Beach  |
| 11  | YPSW | YM MASCULINITY    | 32E    | 2016-05-13 17:00 | Yantian | 2016-05-16 |        | Los Angeles |
| 12  | SEA  | HONG KONG BRIDGE  | 039E   | 2016-05-14 12:00 | Yantian | 2016-05-18 |        | Long Beach  |
| 13  | AAS2 | CMA CGM THALASSA  | 101TXE | 2016-05-16 16:00 | Yantian | 2016-05-19 |        | Long Beach  |



干货箱



|     | 箱体内部尺寸 |      |      | 箱体内容积及载重量 |              | 箱门开度尺寸 |      |
|-----|--------|------|------|-----------|--------------|--------|------|
|     | L      | W    | H    | Cu        | P            | W      | H    |
| 20' | 5898   | 2352 | 2393 | 33.2      | 21740/28230# | 2340   | 2280 |
| 40' | 12032  | 2352 | 2393 | 67.7      | 26630        | 2340   | 2280 |
| HC  | 12032  | 2352 | 2698 | 76.3      | 26520        | 2340   | 2585 |

冷藏箱



|     | 箱体内部尺寸 |      |      | 箱体内容积及载重量 |              |
|-----|--------|------|------|-----------|--------------|
|     | L      | W    | H    | Cu        | P            |
| 20' | 5444   | 2284 | 2267 | 28.5      | 21135/27160# |
| 40' | 11583  | 2284 | 2250 | 58.7      | 26580        |
| HC  | 11583  | 2284 | 2650 | 67.9      | 26380        |

开顶箱



|    | 箱体内部尺寸 |      |      | 箱体内容积及载重量 |       |
|----|--------|------|------|-----------|-------|
|    | L      | W    | P    | Cu        | P     |
| 20 | 5900   | 2330 | 2337 | 32.6      | 21740 |
| 40 | 12025  | 2330 | 2337 | 65.8      | 26410 |

○

○

( ) 实施条件

|  |  |  |
|--|--|--|
|  |  |  |
|  |  |  |
|  |  |  |
|  |  |  |
|  |  |  |

( ) 考核时量

( ) 评分细则

1

|  |  |  |  |  |
|--|--|--|--|--|
|  |  |  |  |  |
|  |  |  |  |  |
|  |  |  |  |  |
|  |  |  |  |  |
|  |  |  |  |  |
|  |  |  |  |  |
|  |  |  |  |  |
|  |  |  |  |  |



|  |  |  |  |  |  |
|--|--|--|--|--|--|
|  |  |  |  |  |  |
|  |  |  |  |  |  |

( ) 任务描述

|  |  |  |  |  |  |  |
|--|--|--|--|--|--|--|
|  |  |  |  |  |  |  |
|  |  |  |  |  |  |  |



|  |  |                          |                          |                          |                          |
|--|--|--------------------------|--------------------------|--------------------------|--------------------------|
|  |  |                          |                          |                          |                          |
|  |  |                          |                          |                          |                          |
|  |  |                          |                          |                          |                          |
|  |  | <input type="checkbox"/> | <input type="checkbox"/> | <input type="checkbox"/> | <input type="checkbox"/> |
|  |  |                          |                          |                          |                          |

|  |  |  |  |  |  |  |  |
|--|--|--|--|--|--|--|--|
|  |  |  |  |  |  |  |  |
|  |  |  |  |  |  |  |  |
|  |  |  |  |  |  |  |  |
| <input type="checkbox"/> <input type="checkbox"/><br><input type="checkbox"/> <input type="checkbox"/> |  |  |  |  |  |  |  |
|  |  |  |  |  |  |  |  |



( ) 实施条件

|  |  |  |
|--|--|--|
|  |  |  |
|  |  |  |
|  |  |  |
|  |  |  |
|  |  |  |

( ) 考核时量

( ) 评分细则

|  |  |  |  |  |
|--|--|--|--|--|
|  |  |  |  |  |
|  |  |  |  |  |
|  |  |  |  |  |
|  |  |  |  |  |





|  |  |  |  |
|--|--|--|--|
|  |  |  |  |
|  |  |  |  |



## 产品运输单

---



- 
- 
- 
- 
- 
- 
- 
-



|  |  |  |
|--|--|--|
|  |  |  |
|  |  |  |
|  |  |  |
|  |  |  |

|    |  |  |  |  |
|----|--|--|--|--|
|    |  |  |  |  |
|    |  |  |  |  |
|    |  |  |  |  |
|    |  |  |  |  |
| 80 |  |  |  |  |
|    |  |  |  |  |
|    |  |  |  |  |
|    |  |  |  |  |
|    |  |  |  |  |





|  |  |  |  |
|--|--|--|--|
|  |  |  |  |
|  |  |  |  |
|  |  |  |  |
|  |  |  |  |
|  |  |  |  |
|  |  |  |  |
|  |  |  |  |
|  |  |  |  |
|  |  |  |  |
|  |  |  |  |
|  |  |  |  |
|  |  |  |  |
|  |  |  |  |
|  |  |  |  |
|  |  |  |  |

|  |  |  |  |
|--|--|--|--|
|  |  |  |  |
|  |  |  |  |



# 产品运输单

---



- 
- 
- 
- 
- 
- 
- 
- 

|  |  |  |
|--|--|--|
|  |  |  |
|  |  |  |
|  |  |  |









|  |  |  |  |
|--|--|--|--|
|  |  |  |  |
|  |  |  |  |
|  |  |  |  |
|  |  |  |  |
|  |  |  |  |
|  |  |  |  |
|  |  |  |  |
|  |  |  |  |
|  |  |  |  |
|  |  |  |  |
|  |  |  |  |
|  |  |  |  |
|  |  |  |  |
|  |  |  |  |
|  |  |  |  |

|  |  |  |  |
|--|--|--|--|
|  |  |  |  |
|  |  |  |  |



# 物品运输单







- 
- 
- 
- 
- 
- 
- 
-







|  |  |  |  |
|--|--|--|--|
|  |  |  |  |
|  |  |  |  |
|  |  |  |  |
|  |  |  |  |
|  |  |  |  |
|  |  |  |  |
|  |  |  |  |
|  |  |  |  |
|  |  |  |  |
|  |  |  |  |
|  |  |  |  |

|  |  |  |  |
|--|--|--|--|
|  |  |  |  |
|  |  |  |  |





# 产品运输单

---



- 
- 
- 
- 
- 
- 
- 
-

|  |  |  |
|--|--|--|
|  |  |  |
|  |  |  |
|  |  |  |





|  |  |  |  |
|--|--|--|--|
|  |  |  |  |
|  |  |  |  |
|  |  |  |  |
|  |  |  |  |
|  |  |  |  |
|  |  |  |  |
|  |  |  |  |
|  |  |  |  |
|  |  |  |  |
|  |  |  |  |
|  |  |  |  |
|  |  |  |  |

|  |  |  |  |
|--|--|--|--|
|  |  |  |  |
|  |  |  |  |



## 产品运输单

---



○

○

○

○

○









|  |  |  |  |
|--|--|--|--|
|  |  |  |  |
|  |  |  |  |
|  |  |  |  |
|  |  |  |  |



## 产品运输单









|  |  |  |  |
|--|--|--|--|
|  |  |  |  |
|  |  |  |  |
|  |  |  |  |
|  |  |  |  |
|  |  |  |  |
|  |  |  |  |
|  |  |  |  |
|  |  |  |  |
|  |  |  |  |
|  |  |  |  |
|  |  |  |  |
|  |  |  |  |
|  |  |  |  |

|  |  |  |  |
|--|--|--|--|
|  |  |  |  |
|  |  |  |  |



# 产品运输单

---



- 
- 
- 
- 
- 
- 
- 
- 
- 

|  |  |  |
|--|--|--|
|  |  |  |
|  |  |  |
|  |  |  |













# 产品运输单

---



- 
- 
- 
- 
- 
- 
- 
-







|  |  |  |  |
|--|--|--|--|
|  |  |  |  |
|  |  |  |  |
|  |  |  |  |
|  |  |  |  |
|  |  |  |  |
|  |  |  |  |
|  |  |  |  |
|  |  |  |  |
|  |  |  |  |
|  |  |  |  |
|  |  |  |  |
|  |  |  |  |
|  |  |  |  |
|  |  |  |  |
|  |  |  |  |

|  |  |  |  |
|--|--|--|--|
|  |  |  |  |
|  |  |  |  |



# 产品运输单

---



- 
- 
- 
- 
- 
- 
- 
- 
- 

|  |  |  |
|--|--|--|
|  |  |  |
|  |  |  |
|  |  |  |













# 产品运输单

---



- 
- 
- 
- 
- 
- 
- 
- 

|  |  |  |
|--|--|--|
|  |  |  |
|  |  |  |
|  |  |  |







○

---



---



---





|  |  |  |
|--|--|--|
|  |  |  |
|  |  |  |

|  |  |  |  |  |  |
|--|--|--|--|--|--|
|  |  |  |  |  |  |
|  |  |  |  |  |  |
|  |  |  |  |  |  |
|  |  |  |  |  |  |
|  |  |  |  |  |  |
|  |  |  |  |  |  |

---

|  |  |  |  |  |  |
|--|--|--|--|--|--|
|  |  |  |  |  |  |
|--|--|--|--|--|--|

---



---



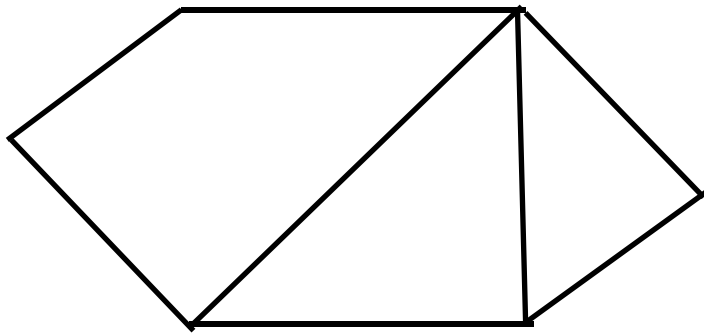



|  |  |  |  |  |
|--|--|--|--|--|
|  |  |  |  |  |
|  |  |  |  |  |
|  |  |  |  |  |
|  |  |  |  |  |
|  |  |  |  |  |
|  |  |  |  |  |
|  |  |  |  |  |

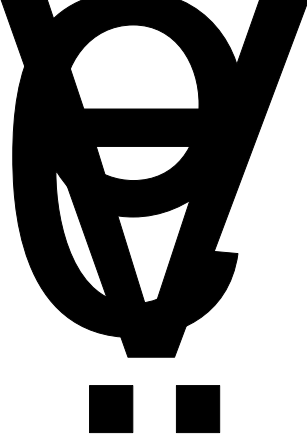

---



---









**1**

---



---



---



---







|  |  |  |
|--|--|--|
|  |  |  |
|  |  |  |
|  |  |  |

|  |  |  |
|--|--|--|
|  |  |  |
|  |  |  |
|  |  |  |

|  |  |  |  |  |
|--|--|--|--|--|
|  |  |  |  |  |
|  |  |  |  |  |
|  |  |  |  |  |
|  |  |  |  |  |
|  |  |  |  |  |
|  |  |  |  |  |
|  |  |  |  |  |
|  |  |  |  |  |

|  |  |  |  |  |  |
|--|--|--|--|--|--|
|  |  |  |  |  |  |
|  |  |  |  |  |  |
|  |  |  |  |  |  |
|  |  |  |  |  |  |
|  |  |  |  |  |  |
|  |  |  |  |  |  |

**1**

---

|  |  |  |  |  |  |
|--|--|--|--|--|--|
|  |  |  |  |  |  |
|  |  |  |  |  |  |
|  |  |  |  |  |  |
|  |  |  |  |  |  |

|  |  |  |  |  |  |
|--|--|--|--|--|--|
|  |  |  |  |  |  |
|--|--|--|--|--|--|

---



---



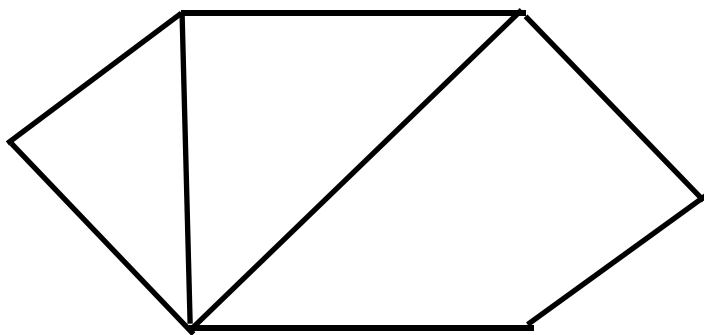

|  |  |  |  |  |
|--|--|--|--|--|
|  |  |  |  |  |
|  |  |  |  |  |
|  |  |  |  |  |
|  |  |  |  |  |
|  |  |  |  |  |
|  |  |  |  |  |





|  |  |  |  |  |  |  |  |  |
|--|--|--|--|--|--|--|--|--|
|  |  |  |  |  |  |  |  |  |
|  |  |  |  |  |  |  |  |  |
|  |  |  |  |  |  |  |  |  |
|  |  |  |  |  |  |  |  |  |
|  |  |  |  |  |  |  |  |  |
|  |  |  |  |  |  |  |  |  |
|  |  |  |  |  |  |  |  |  |
|  |  |  |  |  |  |  |  |  |
|  |  |  |  |  |  |  |  |  |
|  |  |  |  |  |  |  |  |  |
|  |  |  |  |  |  |  |  |  |

|  |  |  |  |  |  |  |  |
|--|--|--|--|--|--|--|--|
|  |  |  |  |  |  |  |  |
|  |  |  |  |  |  |  |  |
|  |  |  |  |  |  |  |  |
|  |  |  |  |  |  |  |  |
|  |  |  |  |  |  |  |  |
|  |  |  |  |  |  |  |  |
|  |  |  |  |  |  |  |  |
|  |  |  |  |  |  |  |  |
|  |  |  |  |  |  |  |  |
|  |  |  |  |  |  |  |  |
|  |  |  |  |  |  |  |  |

|  |  |  |  |  |  |  |  |  |
|--|--|--|--|--|--|--|--|--|
|  |  |  |  |  |  |  |  |  |
|  |  |  |  |  |  |  |  |  |
|  |  |  |  |  |  |  |  |  |
|  |  |  |  |  |  |  |  |  |
|  |  |  |  |  |  |  |  |  |
|  |  |  |  |  |  |  |  |  |
|  |  |  |  |  |  |  |  |  |
|  |  |  |  |  |  |  |  |  |
|  |  |  |  |  |  |  |  |  |
|  |  |  |  |  |  |  |  |  |
|  |  |  |  |  |  |  |  |  |

○

|  |  |  |  |
|--|--|--|--|
|  |  |  |  |
|  |  |  |  |
|  |  |  |  |
|  |  |  |  |
|  |  |  |  |
|  |  |  |  |
|  |  |  |  |
|  |  |  |  |

○

|  |  |
|--|--|
|  |  |
|  |  |
|  |  |

|  |  |
|--|--|
|  |  |
|  |  |

|  |  |  |
|--|--|--|
|  |  |  |
|  |  |  |
|  |  |  |

|  |  |  |  |  |
|--|--|--|--|--|
|  |  |  |  |  |
|  |  |  |  |  |
|  |  |  |  |  |
|  |  |  |  |  |
|  |  |  |  |  |
|  |  |  |  |  |
|  |  |  |  |  |
|  |  |  |  |  |
|  |  |  |  |  |
|  |  |  |  |  |

|  |  |  |  |  |  |
|--|--|--|--|--|--|
|  |  |  |  |  |  |
|  |  |  |  |  |  |
|  |  |  |  |  |  |
|  |  |  |  |  |  |

|  |  |  |  |  |  |  |
|--|--|--|--|--|--|--|
|  |  |  |  |  |  |  |
|  |  |  |  |  |  |  |
|  |  |  |  |  |  |  |
|  |  |  |  |  |  |  |
|  |  |  |  |  |  |  |
|  |  |  |  |  |  |  |



|  |  |  |  |  |  |  |  |  |
|--|--|--|--|--|--|--|--|--|
|  |  |  |  |  |  |  |  |  |
|  |  |  |  |  |  |  |  |  |
|  |  |  |  |  |  |  |  |  |
|  |  |  |  |  |  |  |  |  |
|  |  |  |  |  |  |  |  |  |

|  |  |  |  |  |  |  |  |  |
|--|--|--|--|--|--|--|--|--|
|  |  |  |  |  |  |  |  |  |
|  |  |  |  |  |  |  |  |  |
|  |  |  |  |  |  |  |  |  |
|  |  |  |  |  |  |  |  |  |
|  |  |  |  |  |  |  |  |  |
|  |  |  |  |  |  |  |  |  |
|  |  |  |  |  |  |  |  |  |
|  |  |  |  |  |  |  |  |  |
|  |  |  |  |  |  |  |  |  |
|  |  |  |  |  |  |  |  |  |
|  |  |  |  |  |  |  |  |  |

|  |  |  |  |  |  |  |  |
|--|--|--|--|--|--|--|--|
|  |  |  |  |  |  |  |  |
|  |  |  |  |  |  |  |  |
|  |  |  |  |  |  |  |  |
|  |  |  |  |  |  |  |  |
|  |  |  |  |  |  |  |  |
|  |  |  |  |  |  |  |  |
|  |  |  |  |  |  |  |  |
|  |  |  |  |  |  |  |  |
|  |  |  |  |  |  |  |  |
|  |  |  |  |  |  |  |  |
|  |  |  |  |  |  |  |  |

|  |  |  |  |  |  |  |  |
|--|--|--|--|--|--|--|--|
|  |  |  |  |  |  |  |  |
|  |  |  |  |  |  |  |  |
|  |  |  |  |  |  |  |  |
|  |  |  |  |  |  |  |  |

○

|  |  |  |  |
|--|--|--|--|
|  |  |  |  |
|  |  |  |  |
|  |  |  |  |
|  |  |  |  |
|  |  |  |  |
|  |  |  |  |
|  |  |  |  |
|  |  |  |  |

○

|  |  |
|--|--|
|  |  |
|  |  |
|  |  |

|  |  |
|--|--|
|  |  |
|  |  |

|  |  |  |
|--|--|--|
|  |  |  |
|  |  |  |
|  |  |  |

|  |  |  |  |  |  |
|--|--|--|--|--|--|
|  |  |  |  |  |  |
|  |  |  |  |  |  |
|  |  |  |  |  |  |
|  |  |  |  |  |  |
|  |  |  |  |  |  |
|  |  |  |  |  |  |
|  |  |  |  |  |  |
|  |  |  |  |  |  |
|  |  |  |  |  |  |
|  |  |  |  |  |  |

|  |  |  |  |  |  |
|--|--|--|--|--|--|
|  |  |  |  |  |  |
|  |  |  |  |  |  |
|  |  |  |  |  |  |
|  |  |  |  |  |  |

|  |  |  |  |  |  |  |
|--|--|--|--|--|--|--|
|  |  |  |  |  |  |  |
|  |  |  |  |  |  |  |
|  |  |  |  |  |  |  |
|  |  |  |  |  |  |  |
|  |  |  |  |  |  |  |
|  |  |  |  |  |  |  |
|  |  |  |  |  |  |  |

|  |  |  |  |  |  |  |  |
|--|--|--|--|--|--|--|--|
|  |  |  |  |  |  |  |  |
|  |  |  |  |  |  |  |  |
|  |  |  |  |  |  |  |  |
|  |  |  |  |  |  |  |  |

|  |  |  |  |  |  |  |  |  |
|--|--|--|--|--|--|--|--|--|
|  |  |  |  |  |  |  |  |  |
|  |  |  |  |  |  |  |  |  |
|  |  |  |  |  |  |  |  |  |
|  |  |  |  |  |  |  |  |  |
|  |  |  |  |  |  |  |  |  |
|  |  |  |  |  |  |  |  |  |
|  |  |  |  |  |  |  |  |  |
|  |  |  |  |  |  |  |  |  |
|  |  |  |  |  |  |  |  |  |
|  |  |  |  |  |  |  |  |  |
|  |  |  |  |  |  |  |  |  |

|  |  |  |  |  |  |  |  |  |
|--|--|--|--|--|--|--|--|--|
|  |  |  |  |  |  |  |  |  |
|  |  |  |  |  |  |  |  |  |
|  |  |  |  |  |  |  |  |  |
|  |  |  |  |  |  |  |  |  |



○

|  |  |  |  |
|--|--|--|--|
|  |  |  |  |
|  |  |  |  |
|  |  |  |  |
|  |  |  |  |
|  |  |  |  |
|  |  |  |  |
|  |  |  |  |
|  |  |  |  |

○

|  |  |
|--|--|
|  |  |
|  |  |
|  |  |

|  |  |
|--|--|
|  |  |
|  |  |

|  |  |  |
|--|--|--|
|  |  |  |
|  |  |  |
|  |  |  |

|  |  |  |  |  |
|--|--|--|--|--|
|  |  |  |  |  |
|  |  |  |  |  |
|  |  |  |  |  |
|  |  |  |  |  |
|  |  |  |  |  |
|  |  |  |  |  |
|  |  |  |  |  |
|  |  |  |  |  |
|  |  |  |  |  |
|  |  |  |  |  |

|  |
|--|
|  |
|--|

|  |  |  |  |  |  |
|--|--|--|--|--|--|
|  |  |  |  |  |  |
|  |  |  |  |  |  |
|  |  |  |  |  |  |



|  |  |  |  |  |  |  |
|--|--|--|--|--|--|--|
|  |  |  |  |  |  |  |
|  |  |  |  |  |  |  |
|  |  |  |  |  |  |  |
|  |  |  |  |  |  |  |
|  |  |  |  |  |  |  |
|  |  |  |  |  |  |  |
|  |  |  |  |  |  |  |
|  |  |  |  |  |  |  |
|  |  |  |  |  |  |  |
|  |  |  |  |  |  |  |
|  |  |  |  |  |  |  |

|  |  |  |  |  |  |  |
|--|--|--|--|--|--|--|
|  |  |  |  |  |  |  |
|  |  |  |  |  |  |  |

|  |  |  |  |  |  |  |
|--|--|--|--|--|--|--|
|  |  |  |  |  |  |  |
|  |  |  |  |  |  |  |
|  |  |  |  |  |  |  |
|  |  |  |  |  |  |  |

|  |  |  |  |  |  |  |
|--|--|--|--|--|--|--|
|  |  |  |  |  |  |  |
|  |  |  |  |  |  |  |
|  |  |  |  |  |  |  |
|  |  |  |  |  |  |  |

|  |  |  |  |  |  |  |
|--|--|--|--|--|--|--|
|  |  |  |  |  |  |  |
|  |  |  |  |  |  |  |
|  |  |  |  |  |  |  |
|  |  |  |  |  |  |  |

○

|  |  |  |  |
|--|--|--|--|
|  |  |  |  |
|  |  |  |  |
|  |  |  |  |
|  |  |  |  |
|  |  |  |  |
|  |  |  |  |
|  |  |  |  |
|  |  |  |  |

○

|  |  |
|--|--|
|  |  |
|--|--|

|  |  |
|--|--|
|  |  |
|  |  |
|  |  |
|  |  |



|  |  |  |
|--|--|--|
|  |  |  |
|  |  |  |
|  |  |  |

|  |  |  |  |  |
|--|--|--|--|--|
|  |  |  |  |  |
|  |  |  |  |  |
|  |  |  |  |  |
|  |  |  |  |  |
|  |  |  |  |  |
|  |  |  |  |  |
|  |  |  |  |  |
|  |  |  |  |  |
|  |  |  |  |  |

|  |  |  |  |  |  |
|--|--|--|--|--|--|
|  |  |  |  |  |  |
|  |  |  |  |  |  |
|  |  |  |  |  |  |
|  |  |  |  |  |  |
|  |  |  |  |  |  |

|  |  |  |  |  |  |
|--|--|--|--|--|--|
|  |  |  |  |  |  |
|  |  |  |  |  |  |
|  |  |  |  |  |  |
|  |  |  |  |  |  |
|  |  |  |  |  |  |
|  |  |  |  |  |  |
|  |  |  |  |  |  |

|  |  |  |  |  |  |  |  |
|--|--|--|--|--|--|--|--|
|  |  |  |  |  |  |  |  |
|  |  |  |  |  |  |  |  |
|  |  |  |  |  |  |  |  |
|  |  |  |  |  |  |  |  |

|  |  |  |  |  |  |  |  |
|--|--|--|--|--|--|--|--|
|  |  |  |  |  |  |  |  |
|  |  |  |  |  |  |  |  |
|  |  |  |  |  |  |  |  |
|  |  |  |  |  |  |  |  |
|  |  |  |  |  |  |  |  |
|  |  |  |  |  |  |  |  |
|  |  |  |  |  |  |  |  |
|  |  |  |  |  |  |  |  |
|  |  |  |  |  |  |  |  |
|  |  |  |  |  |  |  |  |
|  |  |  |  |  |  |  |  |

&

○

|  |  |  |  |
|--|--|--|--|
|  |  |  |  |
|  |  |  |  |
|  |  |  |  |
|  |  |  |  |
|  |  |  |  |
|  |  |  |  |
|  |  |  |  |
|  |  |  |  |

○

|  |  |
|--|--|
|  |  |
|  |  |
|  |  |

|  |  |
|--|--|
|  |  |
|  |  |

|  |  |  |
|--|--|--|
|  |  |  |
|  |  |  |

|  |  |  |  |  |  |
|--|--|--|--|--|--|
|  |  |  |  |  |  |
|  |  |  |  |  |  |
|  |  |  |  |  |  |



### 三、国际物流作业组织与管理模块

|  |  |  |
|--|--|--|
|  |  |  |
|  |  |  |
|  |  |  |
|  |  |  |
|  |  |  |

|  |  |  |  |  |
|--|--|--|--|--|
|  |  |  |  |  |
|  |  |  |  |  |
|  |  |  |  |  |

○

|  |  |
|--|--|
|  |  |
|  |  |
|  |  |
|  |  |
|  |  |

|  |  |  |
|--|--|--|
|  |  |  |
|  |  |  |
|  |  |  |
|  |  |  |
|  |  |  |

---

---

---

---

|  |  |  |
|--|--|--|
|  |  |  |
|  |  |  |
|  |  |  |
|  |  |  |
|  |  |  |

|  |  |  |  |  |
|--|--|--|--|--|
|  |  |  |  |  |
|  |  |  |  |  |
|  |  |  |  |  |



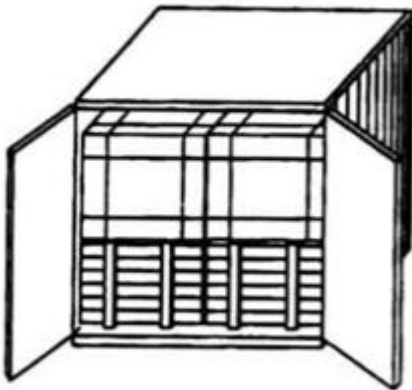
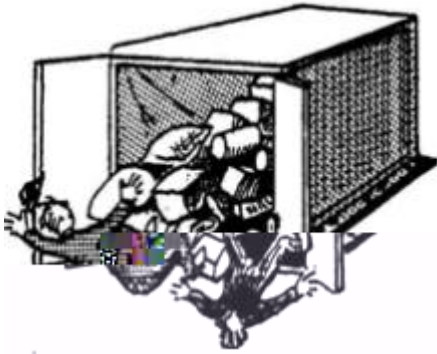
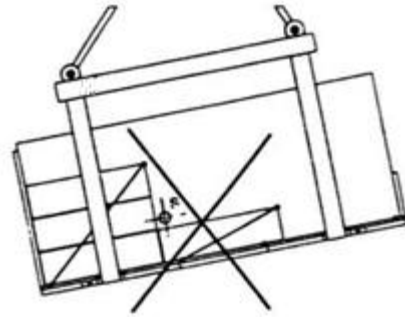

|  |  |  |
|--|--|--|
|  |  |  |
|  |  |  |
|  |  |  |
|  |  |  |
|  |  |  |

|  |  |  |  |  |
|--|--|--|--|--|
|  |  |  |  |  |
|  |  |  |  |  |
|  |  |  |  |  |
|  |  |  |  |  |
|  |  |  |  |  |
|  |  |  |  |  |



|  |  |  |  |  |
|--|--|--|--|--|
|  |  |  |  |  |
|  |  |  |  |  |
|  |  |  |  |  |

○

| 船公司     | 船名/航次 | 服务代码               | 航线                         | 装船港/卸船港                    | 启-达日期                           | 天        | 挂港       |
|---------|-------|--------------------|----------------------------|----------------------------|---------------------------------|----------|----------|
| Carrier |       | Service            | Lane                       | Load/Unload Port           | ETD-ETA                         |          | Day      |
| 0       | 船名    | MSC<br>地中海航运       | MASTER<br>HQ409E           | 中国-香港                      | HONG KONG 香港<br>KAOHSIUNG 高雄    | 02/25(二) | 03/15(六) |
| 1       | 船名    | NYK<br>日本邮船        | ITALIAN EXPRES<br>S/024    | 中国-东南亚                     | HONG KONG 香港<br>BANGKOK 曼谷      | 02/25(二) | 03/02(日) |
| 2       | 船名    | CMA-CGM<br>达飞轮船    | CMA CGM GEMINI<br>TXA49E   | 中国-非洲                      | XIAMEN 厦门<br>DURBAN 德班          | 02/25(二) | 03/27(四) |
| 3       | 船名    | KLINE<br>川崎汽船      | HYUNDAI PLATINU<br>M/004W  | 中国-中南美                     | SHANGHAI 上海<br>PARANAGUA 巴拉那瓜   | 02/25(二) | 04/09(三) |
| 4       | 船名    | DMS<br>达茂轮船        | COSCO KAOHSIUN<br>G/GFS46E | 中国-澳新                      | HONG KONG 香港<br>NOUMEA 努美阿      | 02/25(二) | 04/02(三) |
| 5       | 船名    | RCL<br>招商局         | ROTA PERMASAN<br>VPM114    | 中国-中东/<br>波斯湾/印巴           | QINGDAO 青岛<br>MADRAS 马德拉斯       | 02/28(五) | 03/18(二) |
| 6       | 船名    | ZIM<br>以星轮船        | KUO HUNG<br>311            | CHINA_VIETN<br>AM(CVX)     | NINGBO 宁波<br>HONG KONG 香港       | 02/25(二) | 03/15(六) |
| 7       | 船名    | SAFMARINE<br>比利时商船 | HEIKE P<br>1404            | 中国-非洲                      | KAOHSIUNG 高雄<br>MINDELO         | 02/25(二) | 04/05(六) |
| 8       | 船名    | CSAV<br>南韩船        | CAP SAN NICOLA<br>S/O1409  | 中国-中南美                     | SHANGHAI 上海<br>RIO GRANDE 里奥格兰德 | 02/25(二) | 04/07(一) |
| 9       | 船名    | OOCL<br>东方海外       | DRESDEN EXPRES<br>S/16E08  | Pacific Atl<br>antic (PAX) | SHANGHAI 上海<br>HALIFAX 哈利法克斯    | 02/25(二) | 04/14(一) |

|  |  |  |
|--|--|--|
|  |  |  |
|  |  |  |
|  |  |  |
|  |  |  |
|  |  |  |

|  |  |  |  |  |
|--|--|--|--|--|
|  |  |  |  |  |
|  |  |  |  |  |
|  |  |  |  |  |
|  |  |  |  |  |
|  |  |  |  |  |
|  |  |  |  |  |

|  |  |  |  |  |
|--|--|--|--|--|
|  |  |  |  |  |
|  |  |  |  |  |
|  |  |  |  |  |
|  |  |  |  |  |

○  
○

| BEIJING        | CN  |     | BJS   |
|----------------|-----|-----|-------|
| Y.<br>RENMINBI | CNY |     | KGS   |
|                |     | 100 | 10000 |
|                |     | 100 | 10000 |
|                |     | 100 | 10000 |
|                |     | 100 | 10000 |
|                |     | 100 | 10000 |

|  |  |  |
|--|--|--|
|  |  |  |
|  |  |  |
|  |  |  |
|  |  |  |
|  |  |  |

|  |  |  |  |  |  |
|--|--|--|--|--|--|
|  |  |  |  |  |  |
|  |  |  |  |  |  |
|  |  |  |  |  |  |
|  |  |  |  |  |  |
|  |  |  |  |  |  |
|  |  |  |  |  |  |
|  |  |  |  |  |  |
|  |  |  |  |  |  |
|  |  |  |  |  |  |

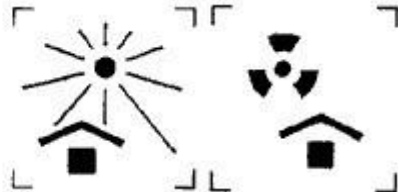

○

|  |  |  |
|--|--|--|
|  |  |  |
|  |  |  |
|  |  |  |
|  |  |  |
|  |  |  |

|  |  |  |  |  |
|--|--|--|--|--|
|  |  |  |  |  |
|  |  |  |  |  |
|  |  |  |  |  |
|  |  |  |  |  |
|  |  |  |  |  |
|  |  |  |  |  |
|  |  |  |  |  |



|  |  |  |  |  |  |
|--|--|--|--|--|--|
|  |  |  |  |  |  |
|  |  |  |  |  |  |
|  |  |  |  |  |  |

○

○

|  |  |  |  |
|--|--|--|--|
|  |  |  |  |
|  |  |  |  |

|  |  |  |
|--|--|--|
|  |  |  |
|  |  |  |
|  |  |  |
|  |  |  |
|  |  |  |

|  |  |  |  |  |
|--|--|--|--|--|
|  |  |  |  |  |
|  |  |  |  |  |
|  |  |  |  |  |
|  |  |  |  |  |



|  |  |  |
|--|--|--|
|  |  |  |
|  |  |  |
|  |  |  |
|  |  |  |
|  |  |  |
|  |  |  |
|  |  |  |
|  |  |  |
|  |  |  |
|  |  |  |

---

---

---

---

---

---

---

---

集装箱设备交接单  
EQUIPMENT INTERCHANGE RECEIPT

OUT 出场

|  |  |   |   |                       |                   |                      |                     |                       |                    |                     |               |                |  |             |                    |              |                       |  |
|--|--|---|---|-----------------------|-------------------|----------------------|---------------------|-----------------------|--------------------|---------------------|---------------|----------------|--|-------------|--------------------|--------------|-----------------------|--|
| 用箱人/运箱人(CNTR. USER/HAULIER)  |  | 提箱地点(PLACE OF DELIVERY)   |   |                       |                   |                      |                     |                       |                    |                     |               |                |  |             |                    |              |                       |  |
| 发往地点(DELIVERED TO)   |  | 返回/收箱地点(PLACE OF RETURN)  |   |                       |                   |                      |                     |                       |                    |                     |               |                |  |             |                    |              |                       |  |
| 船名/航次(VESSEL/VOYAGE No.)   | 集装箱号(CNTR. No.)  | 尺寸/类型(SIZE/TYPE)  | 营运人(CNTR. OPTR)   |                       |                   |                      |                     |                       |                    |                     |               |                |  |             |                    |              |                       |  |
| 船名/航次(VESSEL/VOYAGE No.)   | 集装箱号(CNTR. No.)  | 箱封号(SEAL No.)   | 集装箱号(CNTR. No.)   |                       |                   |                      |                     |                       |                    |                     |               |                |  |             |                    |              |                       |  |
| 进箱日期(TIME-IN)  | 出箱日期/状态(PPS OF GATE-OUT/STATUS)  | 进箱日期/状态(PPS OF GATE-IN/STATUS)  | 出箱日期(TIME-OUT)  |                       |                   |                      |                     |                       |                    |                     |               |                |  |             |                    |              |                       |  |
| 交接地点记录(SPECIFY HERE AT THE TIME OF INTERCHANGE)  |  |   |   |                       |                   |                      |                     |                       |                    |                     |               |                |  |             |                    |              |                       |  |
| 普通集装箱(OR. CNTR.)   | 冷藏集装箱(REF. CNTR.)  | 特种集装箱(SPL. CNTR.)   | 发电机(GEN. SET)   |                       |                   |                      |                     |                       |                    |                     |               |                |  |             |                    |              |                       |  |
| <input type="checkbox"/> 正常(SOUND)<br><input type="checkbox"/> 异常(DEFFECTIVE)  | <input type="checkbox"/> 正常(SOUND) 设定温度(SET)<br><input type="checkbox"/> 异常(DEFFECTIVE) 记录温度(RECORDED) | <input type="checkbox"/> 正常(SOUND)<br><input type="checkbox"/> 异常(DEFFECTIVE) | <input type="checkbox"/> 正常(SOUND)<br><input type="checkbox"/> 异常(DEFFECTIVE) |                       |                   |                      |                     |                       |                    |                     |               |                |  |             |                    |              |                       |  |
| 损坏记录及代号(DAMAGE CODE)   |  |   |   |                       |                   |                      |                     |                       |                    |                     |               |                |  |             |                    |              |                       |  |
| <table border="0"> <tr> <td>BR<br/>破损<br/>(BROKEN)</td> <td>D<br/>凹痕<br/>(DENT)</td> <td>M<br/>缺失<br/>(MISSING)</td> <td>DR<br/>污损<br/>(DIRTY)</td> <td>DL<br/>脏污<br/>(DGLABEL)</td> </tr> <tr> <td>左箱(LLEFT SIDE)<br/></td> <td>右箱(RRIGHT SIDE)<br/></td> <td>前箱(FRONT)<br/></td> <td colspan="2">内部(INSIDE)<br/></td> </tr> <tr> <td>顶部(TOP)<br/></td> <td>底部(FLOOR BASE)<br/></td> <td>后箱(REAR)<br/></td> <td colspan="2">如有异常,请注明程度及尺寸(REMARK)</td> </tr> </table> |  |   |   | BR<br>破损<br>(BROKEN)  | D<br>凹痕<br>(DENT) | M<br>缺失<br>(MISSING) | DR<br>污损<br>(DIRTY) | DL<br>脏污<br>(DGLABEL) | 左箱(LLEFT SIDE)<br> | 右箱(RRIGHT SIDE)<br> | 前箱(FRONT)<br> | 内部(INSIDE)<br> |  | 顶部(TOP)<br> | 底部(FLOOR BASE)<br> | 后箱(REAR)<br> | 如有异常,请注明程度及尺寸(REMARK) |  |
| BR<br>破损<br>(BROKEN)   | D<br>凹痕<br>(DENT)  | M<br>缺失<br>(MISSING)  | DR<br>污损<br>(DIRTY)   | DL<br>脏污<br>(DGLABEL) |                   |                      |                     |                       |                    |                     |               |                |  |             |                    |              |                       |  |
| 左箱(LLEFT SIDE)<br>   | 右箱(RRIGHT SIDE)<br>  | 前箱(FRONT)<br>   | 内部(INSIDE)<br>  |                       |                   |                      |                     |                       |                    |                     |               |                |  |             |                    |              |                       |  |
| 顶部(TOP)<br>  | 底部(FLOOR BASE)<br>   | 后箱(REAR)<br>  | 如有异常,请注明程度及尺寸(REMARK)   |                       |                   |                      |                     |                       |                    |                     |               |                |  |             |                    |              |                       |  |
| 除列明者外,集装箱设备交接时完好无损,箱封完整无误。<br>EQUIPMENT INTERCHANGED IN SOUND CONDITION AND SEAL INTACT UNLESS OTHERWISE STATED  |  | CONTAINER EQ  |   |                       |                   |                      |                     |                       |                    |                     |               |                |  |             |                    |              |                       |  |
| 用箱人/运箱人签署<br>(CONTAINER USER/HAULIER'S SIGNATURE)  |  | 码头/堆场值班员签署<br>(TERMINAL/DEPOT CLERK'S SIGNATURE)                              |   |                       |                   |                      |                     |                       |                    |                     |               |                |  |             |                    |              |                       |  |
| _____日   | _____年_____月_____日   | _____年_____月_____日  | _____年_____月_____日  |                       |                   |                      |                     |                       |                    |                     |               |                |  |             |                    |              |                       |  |

|  |  |  |
|--|--|--|
|  |  |  |
|  |  |  |
|  |  |  |
|  |  |  |
|  |  |  |

|  |  |  |  |  |
|--|--|--|--|--|
|  |  |  |  |  |
|  |  |  |  |  |
|  |  |  |  |  |
|  |  |  |  |  |
|  |  |  |  |  |
|  |  |  |  |  |



|  |  |  |  |  |
|--|--|--|--|--|
|  |  |  |  |  |
|  |  |  |  |  |

|  |  |  |
|--|--|--|
|  |  |  |
|  |  |  |
|  |  |  |



|  |  |  |
|--|--|--|
|  |  |  |
|  |  |  |
|  |  |  |

|  |  |  |  |  |
|--|--|--|--|--|
|  |  |  |  |  |
|  |  |  |  |  |
|  |  |  |  |  |
|  |  |  |  |  |
|  |  |  |  |  |
|  |  |  |  |  |
|  |  |  |  |  |
|  |  |  |  |  |

|  |  |  |  |  |  |
|--|--|--|--|--|--|
|  |  |  |  |  |  |
|--|--|--|--|--|--|

|  |  |  |
|--|--|--|
|  |  |  |
|  |  |  |
|  |  |  |

|  |  |  |
|--|--|--|
|  |  |  |
|  |  |  |

|  |  |  |  |  |
|--|--|--|--|--|
|  |  |  |  |  |
|  |  |  |  |  |
|  |  |  |  |  |
|  |  |  |  |  |
|  |  |  |  |  |
|  |  |  |  |  |
|  |  |  |  |  |
|  |  |  |  |  |



|  |  |  |
|--|--|--|
|  |  |  |
|  |  |  |
|  |  |  |
|  |  |  |
|  |  |  |

|  |  |  |  |  |
|--|--|--|--|--|
|  |  |  |  |  |
|  |  |  |  |  |
|  |  |  |  |  |
|  |  |  |  |  |
|  |  |  |  |  |

|  |  |  |  |  |
|--|--|--|--|--|
|  |  |  |  |  |
|  |  |  |  |  |
|  |  |  |  |  |
|  |  |  |  |  |

|  |  |  |
|--|--|--|
|  |  |  |
|  |  |  |
|  |  |  |
|  |  |  |
|  |  |  |

|  |  |  |  |  |
|--|--|--|--|--|
|  |  |  |  |  |
|  |  |  |  |  |
|  |  |  |  |  |





|  |
|--|
|  |
|  |

|  |  |  |  |  |  |  |  |
|--|--|--|--|--|--|--|--|
|  |  |  |  |  |  |  |  |
|  |  |  |  |  |  |  |  |

|  |  |  |
|--|--|--|
|  |  |  |
|--|--|--|

|  |  |  |
|--|--|--|
|  |  |  |
|  |  |  |
|  |  |  |
|  |  |  |

|  |  |  |  |  |
|--|--|--|--|--|
|  |  |  |  |  |
|  |  |  |  |  |
|  |  |  |  |  |
|  |  |  |  |  |
|  |  |  |  |  |
|  |  |  |  |  |
|  |  |  |  |  |
|  |  |  |  |  |

|  |  |  |  |  |  |
|--|--|--|--|--|--|
|  |  |  |  |  |  |
|--|--|--|--|--|--|



|  |  |  |
|--|--|--|
|  |  |  |
|  |  |  |

|  |  |  |
|--|--|--|
|  |  |  |
|  |  |  |
|  |  |  |
|  |  |  |

|  |  |  |  |  |  |
|--|--|--|--|--|--|
|  |  |  |  |  |  |
|--|--|--|--|--|--|

|  |
|--|
|  |
|  |

|  |  |  |  |  |  |  |  |
|--|--|--|--|--|--|--|--|
|  |  |  |  |  |  |  |  |
|--|--|--|--|--|--|--|--|

|  |  |  |  |  |  |  |  |  |
|--|--|--|--|--|--|--|--|--|
|  |  |  |  |  |  |  |  |  |
|  |  |  |  |  |  |  |  |  |

○



|  |  |  |  |  |  |
|--|--|--|--|--|--|
|  |  |  |  |  |  |
|  |  |  |  |  |  |
|  |  |  |  |  |  |
|  |  |  |  |  |  |
|  |  |  |  |  |  |
|  |  |  |  |  |  |
|  |  |  |  |  |  |
|  |  |  |  |  |  |



|  |  |  |
|--|--|--|
|  |  |  |
|  |  |  |
|  |  |  |
|  |  |  |
|  |  |  |

|  |  |  |  |  |
|--|--|--|--|--|
|  |  |  |  |  |
|  |  |  |  |  |
|  |  |  |  |  |





|  |  |  |  |
|--|--|--|--|
|  |  |  |  |
|  |  |  |  |
|  |  |  |  |
|  |  |  |  |
|  |  |  |  |
|  |  |  |  |
|  |  |  |  |

|  |  |  |  |  |  |
|--|--|--|--|--|--|
|  |  |  |  |  |  |
|  |  |  |  |  |  |
|  |  |  |  |  |  |
|  |  |  |  |  |  |
|  |  |  |  |  |  |
|  |  |  |  |  |  |
|  |  |  |  |  |  |
|  |  |  |  |  |  |

4 1/2 1/2 1/2 1/2 1/2

|  |  |  |
|--|--|--|
|  |  |  |
|  |  |  |
|  |  |  |
|  |  |  |
|  |  |  |

7 + 1 C





|  |  |  |
|--|--|--|
|  |  |  |
|  |  |  |
|  |  |  |
|  |  |  |
|  |  |  |

|  |  |  |  |  |
|--|--|--|--|--|
|  |  |  |  |  |
|  |  |  |  |  |



○

|  |  |  |
|--|--|--|
|  |  |  |
|  |  |  |
|  |  |  |
|  |  |  |
|  |  |  |

|  |  |  |
|--|--|--|
|  |  |  |
|--|--|--|

|  |  |  |  |  |
|--|--|--|--|--|
|  |  |  |  |  |
|  |  |  |  |  |
|  |  |  |  |  |
|  |  |  |  |  |
|  |  |  |  |  |
|  |  |  |  |  |
|  |  |  |  |  |
|  |  |  |  |  |



|  |  |  |
|--|--|--|
|  |  |  |
|  |  |  |
|  |  |  |
|  |  |  |
|  |  |  |

|  |  |  |  |  |
|--|--|--|--|--|
|  |  |  |  |  |
|  |  |  |  |  |
|  |  |  |  |  |
|  |  |  |  |  |
|  |  |  |  |  |
|  |  |  |  |  |

|  |  |  |  |  |
|--|--|--|--|--|
|  |  |  |  |  |
|  |  |  |  |  |
|  |  |  |  |  |

|  |  |  |
|--|--|--|
|  |  |  |
|  |  |  |



|  |  |  |
|--|--|--|
|  |  |  |
|  |  |  |
|  |  |  |

|  |  |  |  |  |
|--|--|--|--|--|
|  |  |  |  |  |
|  |  |  |  |  |
|  |  |  |  |  |
|  |  |  |  |  |
|  |  |  |  |  |
|  |  |  |  |  |
|  |  |  |  |  |
|  |  |  |  |  |

|  |  |  |  |  |  |
|--|--|--|--|--|--|
|  |  |  |  |  |  |
|--|--|--|--|--|--|

○

○

○

|  |  |  |
|--|--|--|
|  |  |  |
|  |  |  |
|  |  |  |
|  |  |  |
|  |  |  |



○

|  |  |  |
|--|--|--|
|  |  |  |
|  |  |  |
|  |  |  |
|  |  |  |
|  |  |  |

|  |  |  |  |  |
|--|--|--|--|--|
|  |  |  |  |  |
|  |  |  |  |  |
|  |  |  |  |  |



|  |  |  |
|--|--|--|
|  |  |  |
|  |  |  |
|  |  |  |
|  |  |  |
|  |  |  |

|  |  |  |  |  |
|--|--|--|--|--|
|  |  |  |  |  |
|  |  |  |  |  |
|  |  |  |  |  |
|  |  |  |  |  |

|  |  |  |  |  |
|--|--|--|--|--|
|  |  |  |  |  |
|  |  |  |  |  |
|  |  |  |  |  |
|  |  |  |  |  |

#### 四、 快递物流作业组织与管理模块



|  |  |  |
|--|--|--|
|  |  |  |
|  |  |  |
|  |  |  |

|  |  |  |
|--|--|--|
|  |  |  |
|  |  |  |
|  |  |  |



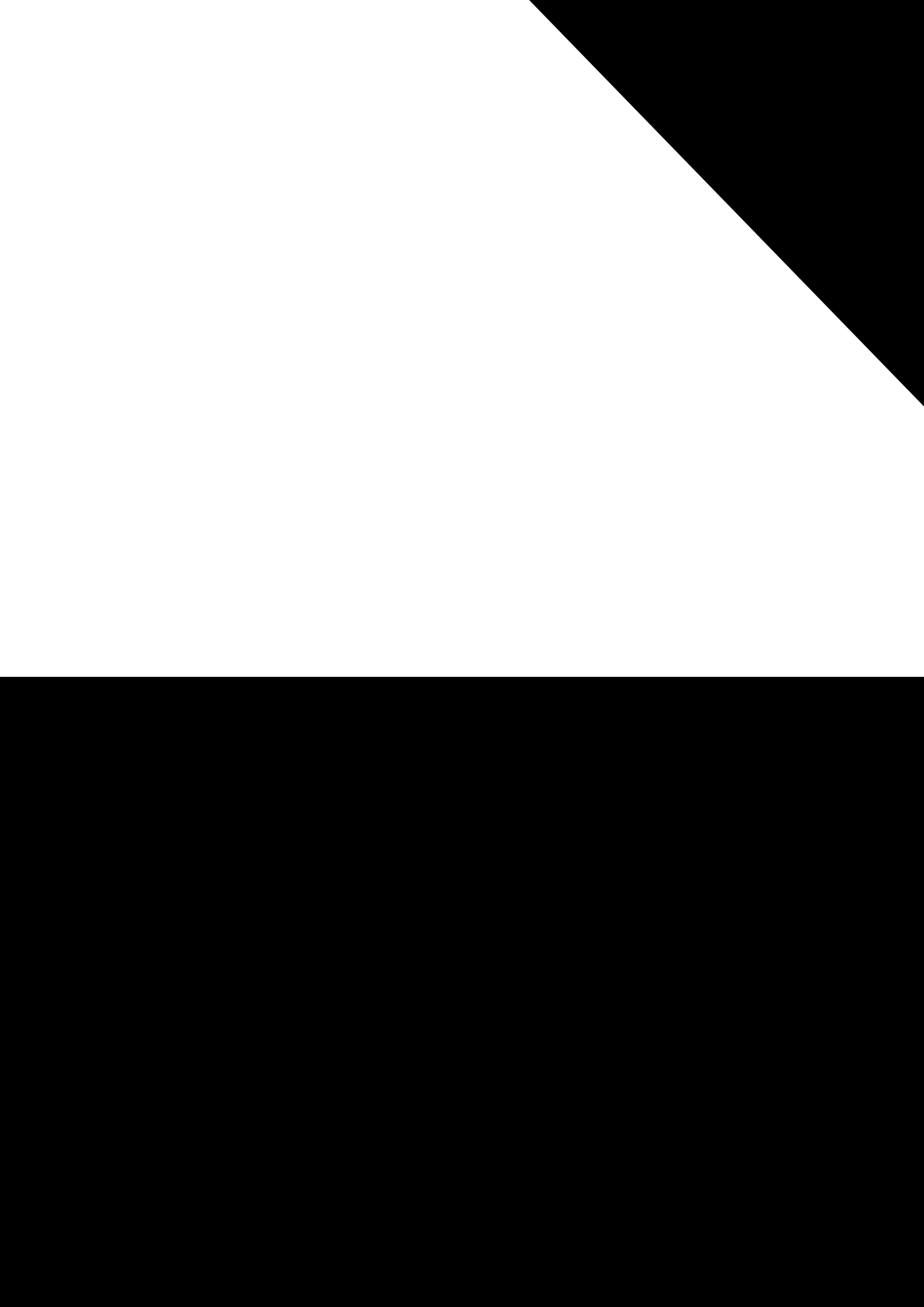

|  |  |  |
|--|--|--|
|  |  |  |
|  |  |  |
|  |  |  |

|  |  |  |
|--|--|--|
|  |  |  |
|  |  |  |
|  |  |  |







|  |  |  |
|--|--|--|
|  |  |  |
|  |  |  |
|  |  |  |

|  |  |  |
|--|--|--|
|  |  |  |
|  |  |  |





|  |  |  |  |  |  |
|--|--|--|--|--|--|
|  |  |  |  |  |  |
|--|--|--|--|--|--|

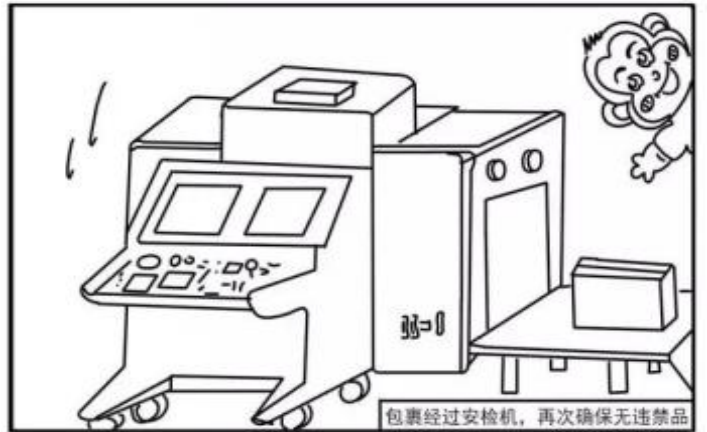

|  |  |  |
|--|--|--|
|  |  |  |
|  |  |  |
|  |  |  |

|  |  |  |
|--|--|--|
|  |  |  |
|  |  |  |
|  |  |  |
|  |  |  |

|  |  |  |  |  |  |
|--|--|--|--|--|--|
|  |  |  |  |  |  |
|--|--|--|--|--|--|



L€œ( œ\* 5Š

'ÊR'#D @5

|  |  |  |
|--|--|--|
|  |  |  |
|  |  |  |
|  |  |  |

|  |  |  |
|--|--|--|
|  |  |  |
|  |  |  |
|  |  |  |
|  |  |  |
|  |  |  |







|  |  |  |
|--|--|--|
|  |  |  |
|  |  |  |
|  |  |  |

|  |  |  |
|--|--|--|
|  |  |  |
|  |  |  |
|  |  |  |
|  |  |  |
|  |  |  |



---

|  |  |  |
|--|--|--|
|  |  |  |
|  |  |  |
|  |  |  |

|  |  |  |
|--|--|--|
|  |  |  |
|  |  |  |



|  |  |  |  |  |  |
|--|--|--|--|--|--|
|  |  |  |  |  |  |
|--|--|--|--|--|--|



[想知道:中国成都理工大学校园快递具体在哪? 百度知道](#)

3个回答 - 提问时间: 2014年02月10日

最佳答案:  均在银杏后面。宝盒、圆通、顺丰在电影院后面。中通、申通在图书馆下面。常用的是这几个。

[zhidao.baidu.com/link?...](http://zhidao.baidu.com/link?...) 2014-02-15 - 百度快照 - 80%好评









|  |  |  |
|--|--|--|
|  |  |  |
|  |  |  |
|  |  |  |

|  |  |  |
|--|--|--|
|  |  |  |
|  |  |  |
|  |  |  |
|  |  |  |
|  |  |  |

|  |  |  |  |  |
|--|--|--|--|--|
|  |  |  |  |  |
|  |  |  |  |  |
|  |  |  |  |  |
|  |  |  |  |  |
|  |  |  |  |  |
|  |  |  |  |  |
|  |  |  |  |  |
|  |  |  |  |  |

|  |  |  |  |  |  |
|--|--|--|--|--|--|
|  |  |  |  |  |  |
|  |  |  |  |  |  |
|  |  |  |  |  |  |





|  |  |  |
|--|--|--|
|  |  |  |
|  |  |  |
|  |  |  |

|  |  |  |
|--|--|--|
|  |  |  |
|  |  |  |
|  |  |  |
|  |  |  |
|  |  |  |

|  |  |  |  |
|--|--|--|--|
|  |  |  |  |
|--|--|--|--|





|  |  |  |
|--|--|--|
|  |  |  |
|  |  |  |
|  |  |  |
|  |  |  |
|  |  |  |





|  |  |  |
|--|--|--|
|  |  |  |
|  |  |  |
|  |  |  |
|  |  |  |
|  |  |  |







|  |  |  |
|--|--|--|
|  |  |  |
|  |  |  |
|  |  |  |
|  |  |  |
|  |  |  |

|  |  |  |  |
|--|--|--|--|
|  |  |  |  |
|--|--|--|--|





Prionia







|  |  |  |
|--|--|--|
|  |  |  |
|  |  |  |
|  |  |  |
|  |  |  |
|  |  |  |





|  |  |  |
|--|--|--|
|  |  |  |
|  |  |  |
|  |  |  |
|  |  |  |
|  |  |  |

|  |  |  |  |  |
|--|--|--|--|--|
|  |  |  |  |  |
|  |  |  |  |  |
|  |  |  |  |  |

















|  |  |  |  |  |  |
|--|--|--|--|--|--|
|  |  |  |  |  |  |
|  |  |  |  |  |  |
|  |  |  |  |  |  |
|  |  |  |  |  |  |



|  |  |  |
|--|--|--|
|  |  |  |
|  |  |  |
|  |  |  |
|  |  |  |
|  |  |  |

|  |  |  |  |  |  |
|--|--|--|--|--|--|
|  |  |  |  |  |  |
|  |  |  |  |  |  |
|  |  |  |  |  |  |
|  |  |  |  |  |  |
|  |  |  |  |  |  |





|  |  |  |
|--|--|--|
|  |  |  |
|  |  |  |
|  |  |  |
|  |  |  |
|  |  |  |

|  |  |  |  |  |
|--|--|--|--|--|
|  |  |  |  |  |
|  |  |  |  |  |
|  |  |  |  |  |
|  |  |  |  |  |





|  |  |  |
|--|--|--|
|  |  |  |
|  |  |  |
|  |  |  |
|  |  |  |
|  |  |  |

|  |  |  |  |  |
|--|--|--|--|--|
|  |  |  |  |  |
|  |  |  |  |  |
|  |  |  |  |  |











|  |  |  |  |  |  |
|--|--|--|--|--|--|
|  |  |  |  |  |  |
|  |  |  |  |  |  |
|  |  |  |  |  |  |
|  |  |  |  |  |  |









|  |  |  |
|--|--|--|
|  |  |  |
|  |  |  |
|  |  |  |
|  |  |  |
|  |  |  |

|  |  |  |  |  |  |
|--|--|--|--|--|--|
|  |  |  |  |  |  |
|  |  |  |  |  |  |
|  |  |  |  |  |  |
|  |  |  |  |  |  |
|  |  |  |  |  |  |





|  |  |  |
|--|--|--|
|  |  |  |
|  |  |  |
|  |  |  |
|  |  |  |
|  |  |  |

|       |
|-------|
| <hr/> |
|-------|

